

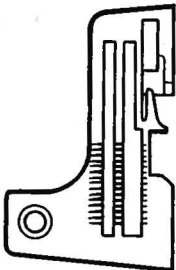

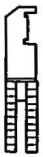

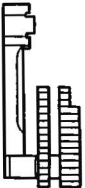



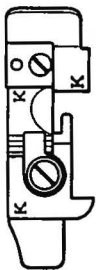
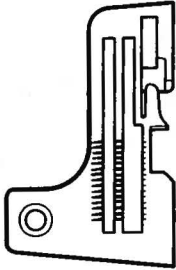

EF4 - B956
EF4 - B957
MA4 - B972

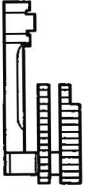
High Speed Overlocker Gauge Parts

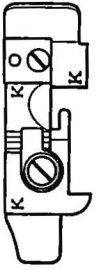
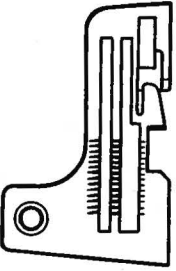

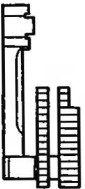

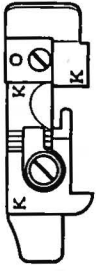

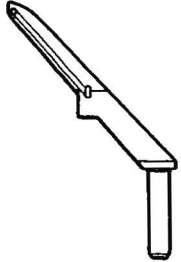
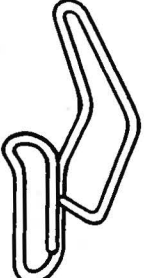
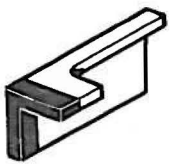
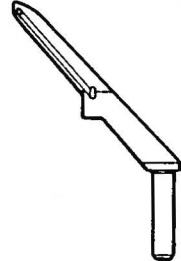
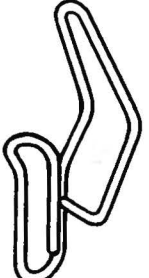
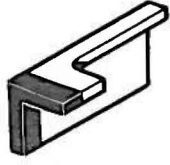
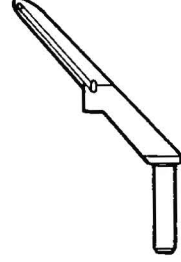
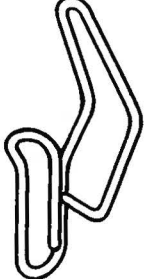
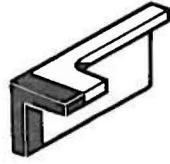

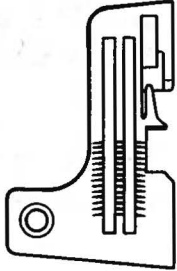
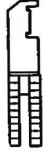
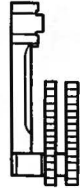

I 2080160

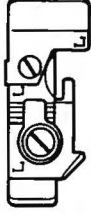
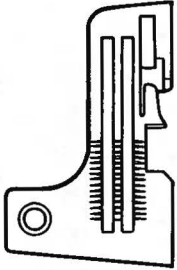

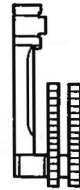

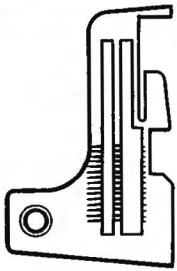
EF4-B956

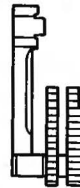
Sub class	Needle plate	Main feed dog	Differential feed dog	Chain feed dog	Presser foot complete
EF4-B956-01 Overlock width 3mm 3 thread overlock	 140444-0-01	 140450-0-01	 140452-0-01	 142197-0-01	 140460-0-01
EF4-B956-01 Overlock width 4mm 3 thread overlock	 140445-0-01	 140450-0-01	 140452-0-01	 142197-0-01	 140460-0-01
EF4-B956-01 Overlock width 5mm 3 thread overlock	 142346-0-01	 140450-0-01	 140452-0-01	 142197-0-01	 140460-0-01



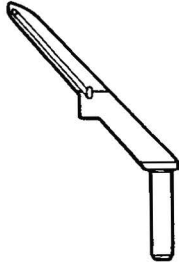

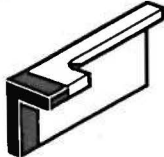
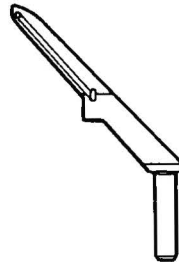
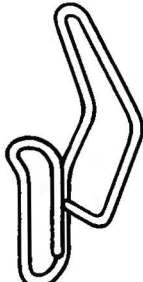
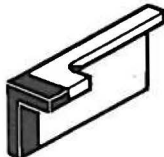
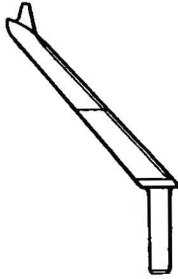

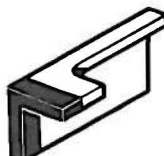

Over looper	Needle thread take-up	Upper knife	Note
 <p data-bbox="415 544 556 568">143733-0-01</p>	 <p data-bbox="745 544 886 568">142602-0-01</p>	 <p data-bbox="1081 544 1222 568">140242-0-01</p>	<p data-bbox="1323 267 1942 332">(1) Alternation of sub class from -01 to -09, you can change it by only replacing respective gauges.</p>
 <p data-bbox="415 885 556 909">143733-0-01</p>	 <p data-bbox="745 885 886 909">142602-0-01</p>	 <p data-bbox="1081 885 1222 909">140242-0-01</p>	<p data-bbox="1323 625 1932 690">(2) Alternation of sub class from -01 & -09 to -11, the stitch length is limited upto 3.6mm.</p>
 <p data-bbox="415 1226 556 1250">143733-0-01</p>	 <p data-bbox="745 1226 886 1250">142602-0-01</p>	 <p data-bbox="1081 1226 1222 1250">140242-0-01</p>	<p data-bbox="1323 966 1932 1063">(3) Alternation of sub class from -11 to -01 & -09, the stitch must be limited upto 3.6mm to avoid any breakage, although it can get upto 5.0mm.</p>

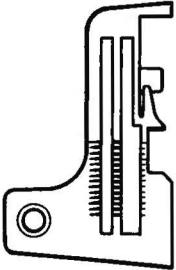

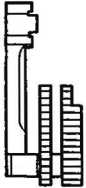
EF4-B956

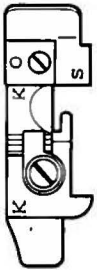
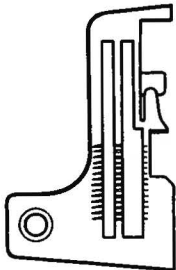
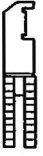
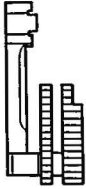
Sub class	Needle plate	Main feed dog	Differential feed dog	Chain feed dog	Presser foot complete
EF4-B956-09 Overlock width 3mm 3 thread overlock	 142191-0-01	 140450-0-01	 142196-0-01	 142197-0-01	 142199-0-01
EF4-B956-09 Overlock width 4mm 3 thread overlock	 142192-0-01	 140450-0-01	 142196-0-01	 142197-0-01	 142199-0-01
EF4-B956-11 Overlock width 5mm thread overlock	 143150-0-01	 140450-0-01	 140453-0-01	 143152-0-01	 143153-0-01

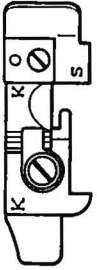
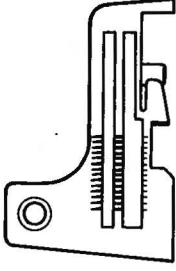
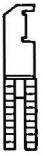
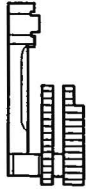

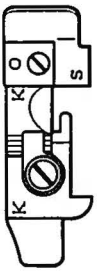

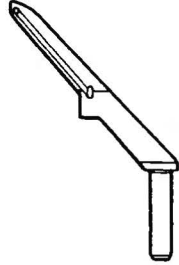
Over looper	Needle thread take-up	Upper knife	Note
 <p data-bbox="422 560 558 581">143733-0-01</p>	 <p data-bbox="760 560 896 581">142602-0-01</p>	 <p data-bbox="1077 560 1213 581">142198-0-01</p>	
 <p data-bbox="422 906 558 927">143733-0-01</p>	 <p data-bbox="760 906 896 927">142602-0-01</p>	 <p data-bbox="1077 906 1213 927">142198-0-01</p>	
 <p data-bbox="426 1250 562 1271">143151-0-01</p>	 <p data-bbox="772 1250 909 1271">142201-0-01</p>	 <p data-bbox="1077 1250 1213 1271">140242-0-01</p>	

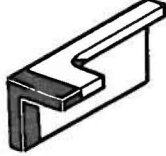
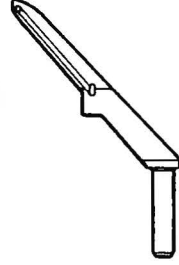
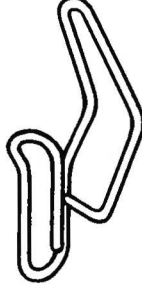
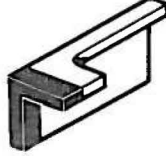
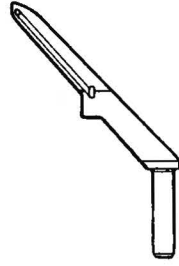
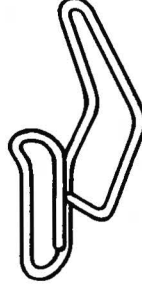
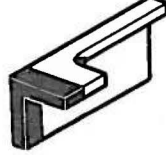

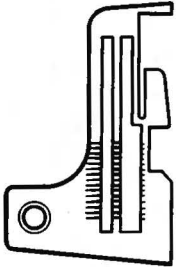
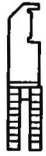
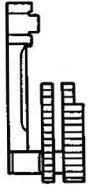

EF4-B956

Sub class	Needle plate	Main feed dog	Differential feed dog	Chain feed dog	Presser foot complete
<p>EF4-B956-101</p> <p>Overlock width 3mm</p> <p>3 thread overlock</p>	 143313-0-01	 140450-0-01	 140452-0-01	 142197-0-01	 143364-0-01
<p>EF4-B956-101</p> <p>Overlock width 4mm</p> <p>3 thread overlock</p>	 143314-0-01	 140450-0-01	 140452-0-01	 142197-0-01	 143364-0-01
<p>EF4-B956-101</p> <p>Overlock width 5mm</p> <p>3 thread overlock</p>	 143318-0-01	 140450-0-01	 140452-0-01	 142197-0-01	 143364-0-01

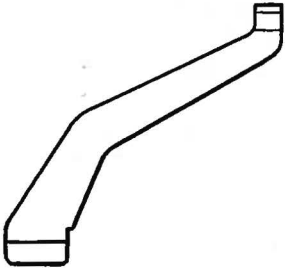
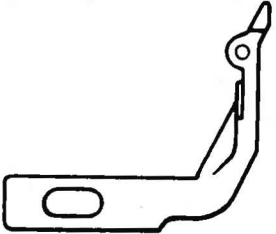

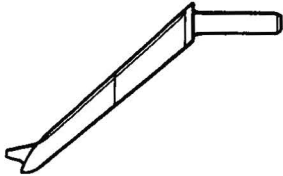

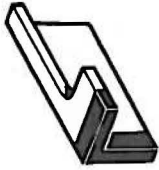
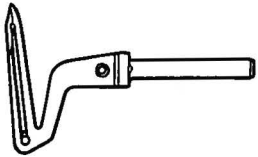



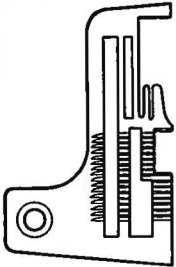
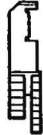
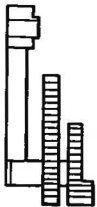

Over looper	Needle thread take-up	Upper knife	Note
 <p data-bbox="428 558 583 581">143733-0-01</p>	 <p data-bbox="772 558 928 581">142602-0-01</p>	 <p data-bbox="1104 558 1260 581">140242-0-01</p>	
 <p data-bbox="428 899 583 922">143733-0-01</p>	 <p data-bbox="772 899 928 922">142602-0-01</p>	 <p data-bbox="1104 899 1260 922">140242-0-01</p>	
 <p data-bbox="428 1248 583 1271">143733-0-01</p>	 <p data-bbox="772 1248 928 1271">142602-0-01</p>	 <p data-bbox="1104 1248 1260 1271">140242-0-01</p>	

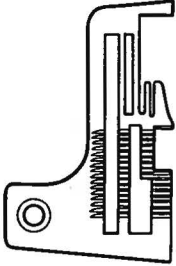
EF4-B956

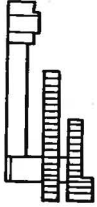
Sub class	Needle plate	Main feed dog	Differential feed dog	Chain feed	Presser foot complete
<p>EF4-B956-111</p> <p>Overlock width 5mm</p> <p>2 thread overlock</p>	 <p>143150-0-01</p>	 <p>140451-0-01</p>	 <p>140453-0-01</p>	 <p>143152-0-01</p>	 <p>144544-0-01</p>
<p>Gauges commonly used on all sub-classes</p>	<p>Needle clamp complete</p>  <p>143761-0-01</p>			<p>Needle guard (B)</p>  <p>143753-0-01</p>	<p>Needle guard (F)</p>  <p>143752-0-01</p>

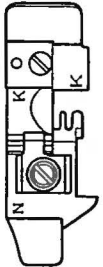
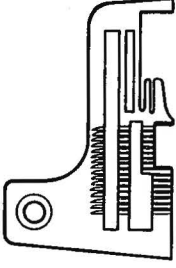





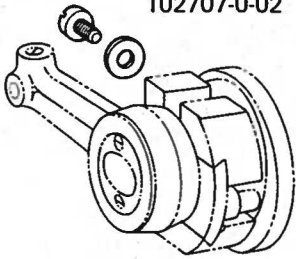
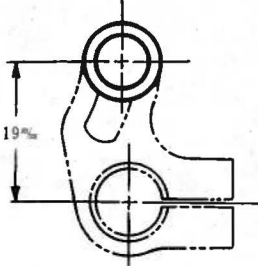
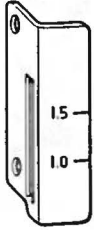
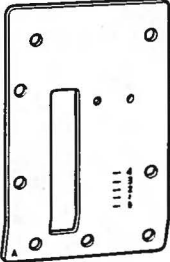
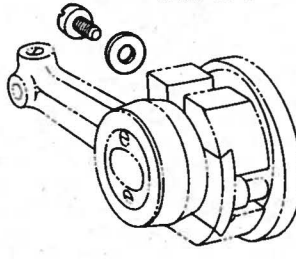
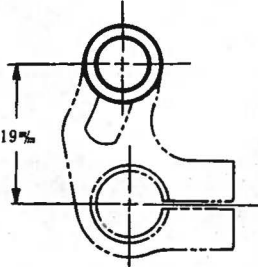
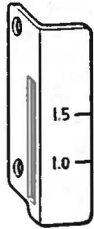
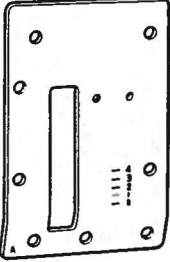
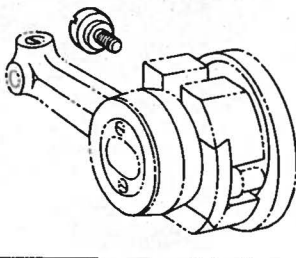
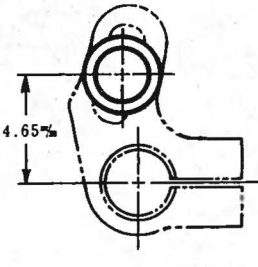
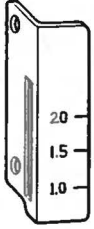
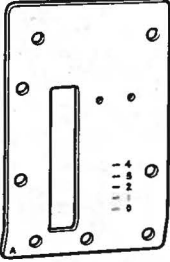

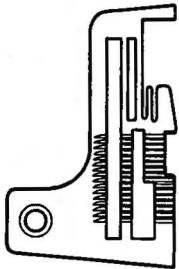

<p>Over looper</p>  <p>143151-0-01</p>	<p>Needle thread take - up</p>  <p>142201-0-01</p>	<p>Upper knife</p>  <p>140242-0-01</p>	<p>Note</p>
<p>Under looper</p>  <p>143734-0-01</p> <p>Lower knife</p>  <p>118527-0-01</p>			

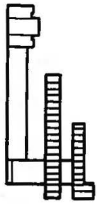
EF4-B957

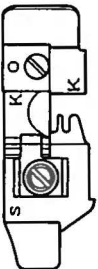
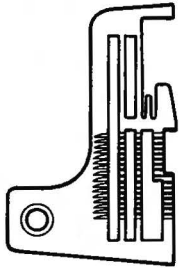
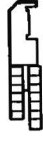
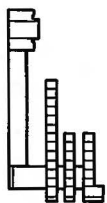

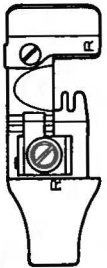
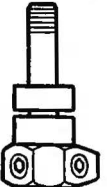

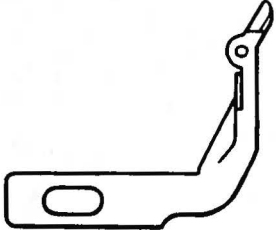

Sub class	Needle plate	Main feed dog	Differential feed dog	Chain feed dog	Presser foot complete
<p>EF4-B957-1</p> <p>Needle gauge 2.2mm</p> <p>Overlock width 5mm</p> <p>4 thread overlock</p>	 144020-0-01	 144064-0-01	 144067-0-01	 144070-0-01	 144089-0-01
<p>EF4-B957-2</p> <p>Needle gauge 2.2mm</p> <p>Overlock width 6mm</p> <p>4 thread overlock</p> <p>(Mock safety)</p>	 144021-0-01	 144064-0-01	 144067-0-01	 144070-0-01	 144089-0-01
<p>EF4-B957-3</p> <p>Needle gauge 2.2mm</p> <p>Overlock width 5mm</p> <p>4 thread overlock</p>	 144020-0-01	 144062-0-01	 144065-0-01	 144070-0-01	 144089-0-01

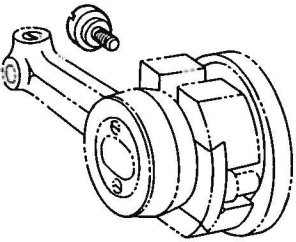
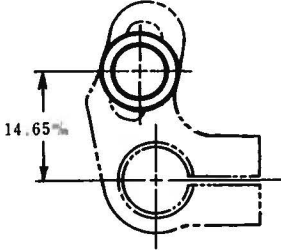
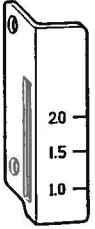
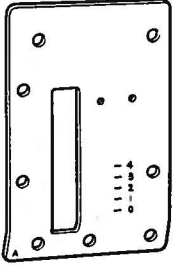
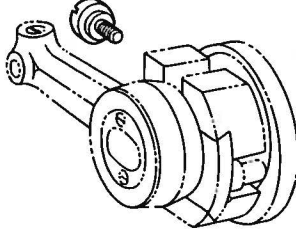
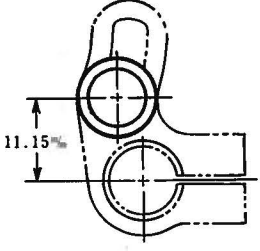
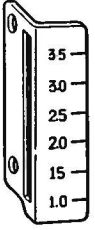
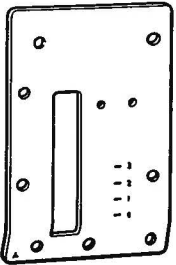
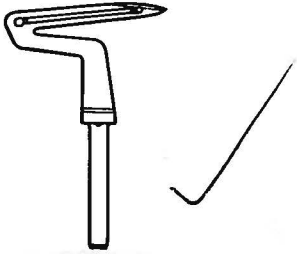
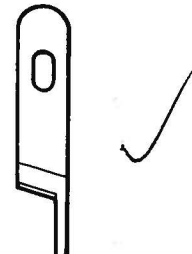
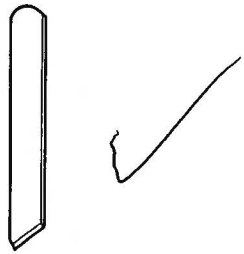
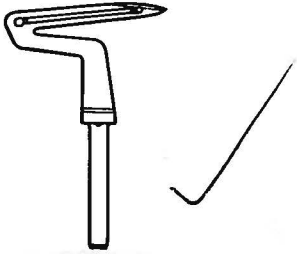
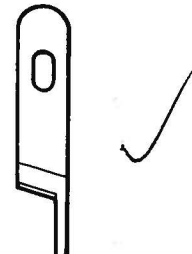
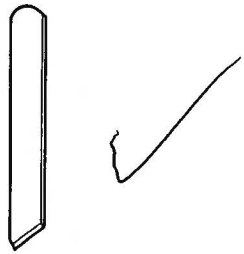
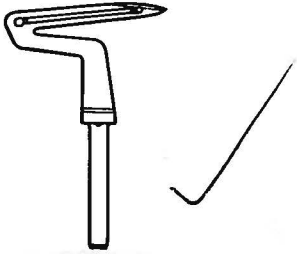
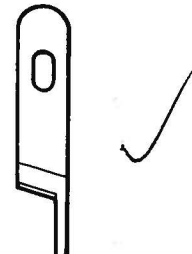
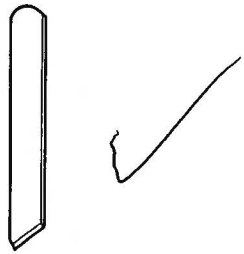
Eccentric adjusting screw	Main feed shaft set position	Differential stitch control	Face plate	
<p>105123-0-03 102707-0-02</p> 		 <p>144096-0-01</p>	 <p>144613-0-01</p>	
<p>105123-0-03 102707-0-02</p> 		 <p>144096-0-01</p>	 <p>144613-0-01</p>	
<p>144058-0-01</p> 		 <p>144095-0-01</p>	 <p>144612-0-01</p>	

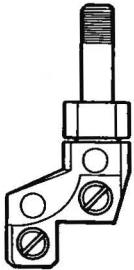
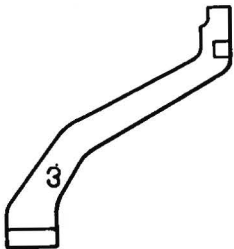
EF4-B957

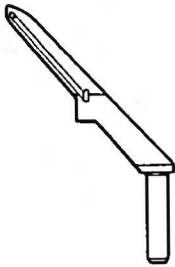

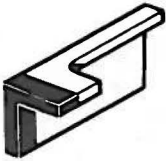
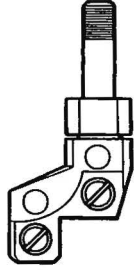
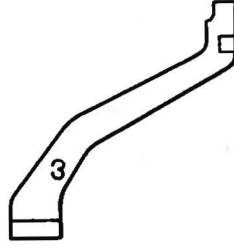
Sub class	Needle plate	Main feed dog	Differential feed dog	Chain feed dog	Presser foot complete
<p>EF4-B957-4 Needle gauge 2.2mm Overlock width 7mm 4 thread overlock (Mock safety)</p>	 144024-0-01	 144062-0-01	 144065-0-01	 144070-0-01	 144101-0-01
<p>EF4-B957-5 Needle gauge 2.2mm Overlock width 7mm 4 thread overlock</p>	 144022-0-01	 144063-0-01	 144066-0-01	 144069-0-01	 144097-0-01
<p>Gauges commonly used on all sub-classes</p>	<p>Needle clamp complete</p>  144017-0-01	<p>Movable needle guard</p>  144127-0-01	<p>Needle guard(B)</p>  144126-0-01		<p>Over looper</p>  144042-0-01

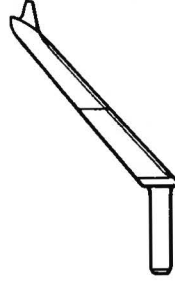
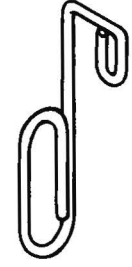
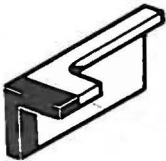
Eccentric adjusting screw	Main feed shaft set position	Differential ratio plate	Face plate				
<p>144058-0-01</p> 	 <p>14.65"</p>	 <p>144095-0-01</p>	 <p>144612-0-01</p>				
<p>144058-0-01</p> 	 <p>11.15"</p>	 <p>144094-0-01</p>	 <p>143995-0-01</p>				
<table border="0" style="width: 100%; text-align: center;"> <tr> <td data-bbox="331 946 703 1292"> <p>Under looper</p>  <p>144049-0-01</p> </td> <td data-bbox="703 946 995 1292"> <p>Upper knife</p>  <p>144074-0-01</p> </td> <td data-bbox="995 946 1976 1292"> <p>Lower knife</p>  <p>144077-0-01</p> </td> </tr> </table>					<p>Under looper</p>  <p>144049-0-01</p>	<p>Upper knife</p>  <p>144074-0-01</p>	<p>Lower knife</p>  <p>144077-0-01</p>
<p>Under looper</p>  <p>144049-0-01</p>	<p>Upper knife</p>  <p>144074-0-01</p>	<p>Lower knife</p>  <p>144077-0-01</p>					

Needle clamp complete	Needle guard (overlock stitch)	Needle guard (chain stitch)	Over looper	Needle thread take-up	Upper knife
 <p>142126-0-01</p>	 <p>140108-0-03</p>	 <p>140997-0-01</p>	 <p>143733-0-01</p>	 <p>142602-0-01</p>	 <p>140242-0-01</p>
 <p>142126-0-01</p>	 <p>140108-0-03</p>	 <p>140997-0-01</p>	 <p>143151-0-01</p>	 <p>142201-0-01</p>	 <p>140242-0-01</p>

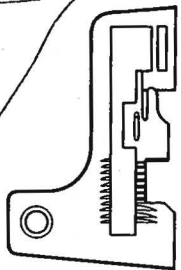
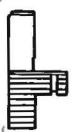
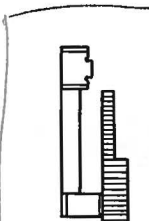
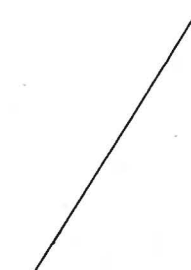
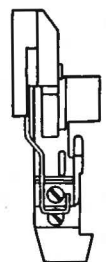
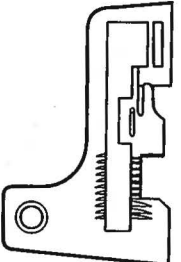
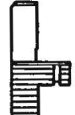
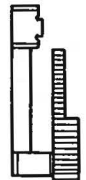
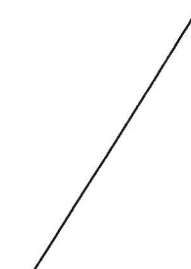
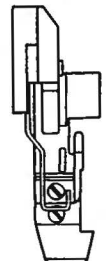
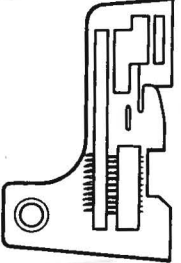
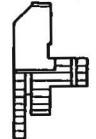
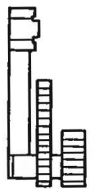
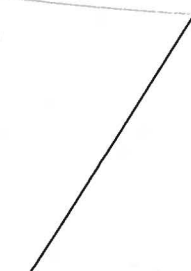
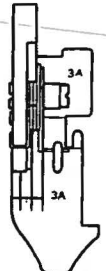

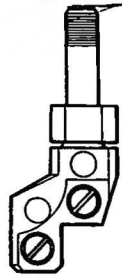
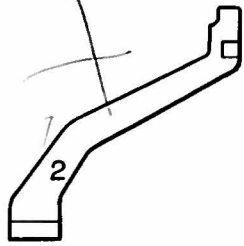

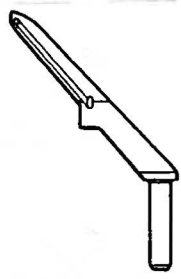
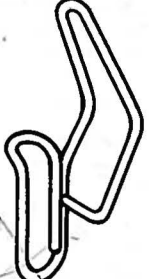
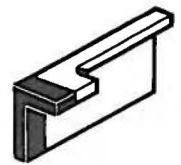
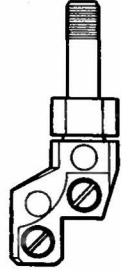
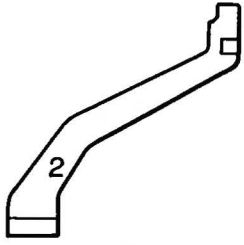
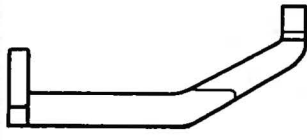
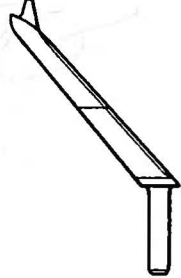
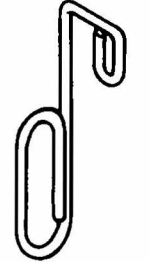
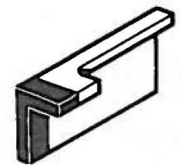
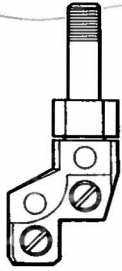
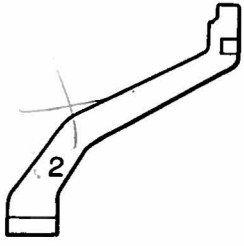
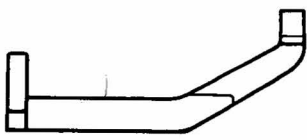
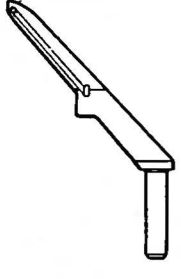
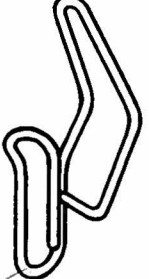
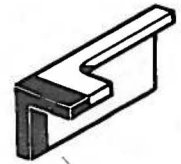



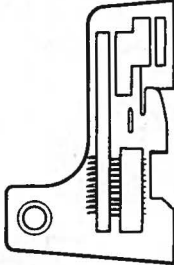
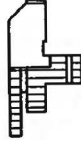
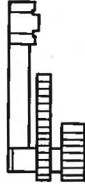
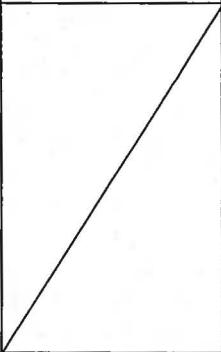
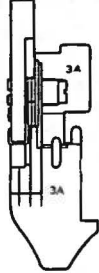
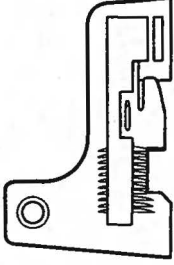
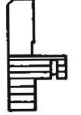
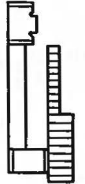
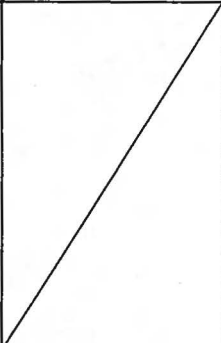
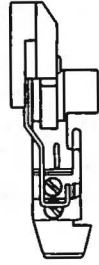
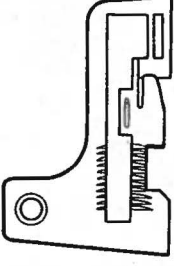
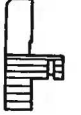
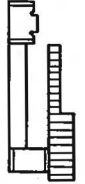
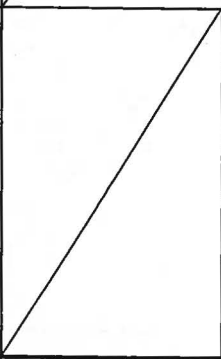
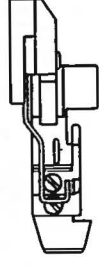

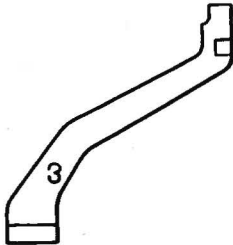
MA4-B972

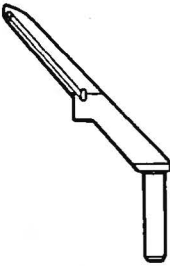
Sub class	Needle plate	Main feed dog	Differential feed dog	Chain feed dog	Presser foot complete
<p>MA4-B972-2 A</p> <p>Needle gauge 2mm</p> <p>Overlock width 3mm</p> <p>5 thread safety stitch</p>	 <p>142249-0-01</p>	 <p>142370-0-01</p>	 <p>142371-0-01</p>		 <p>142250-0-01</p>
<p>MA4-B972-2 B</p> <p>Needle gauge 2mm</p> <p>Overlock width 3mm</p> <p>4 thread safety stitch</p>	 <p>142249-0-01</p>	 <p>142370-0-01</p>	 <p>142371-0-01</p>		 <p>142250-0-01</p>
<p>MA4-B972-3 A</p> <p>Needle gauge 3mm</p> <p>Overlock width 5mm</p> <p>5 thread safety stitch</p>	 <p>143296-0-01</p>	 <p>143297-0-01</p>	 <p>140194-0-01</p>		 <p>140268-0-01</p>

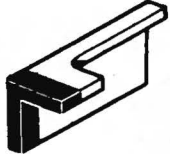
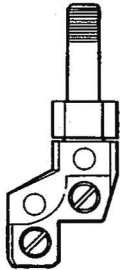
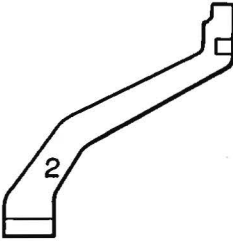

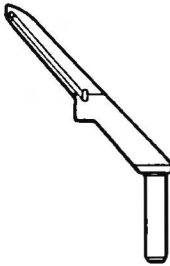

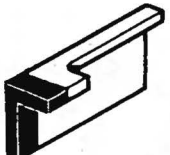

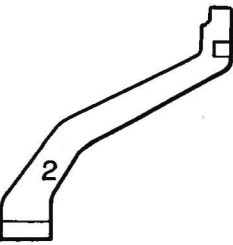
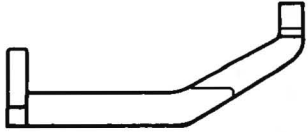
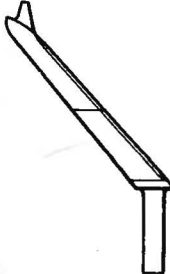
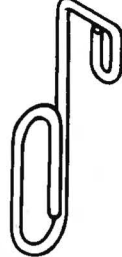
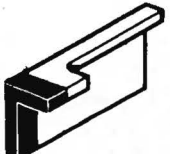

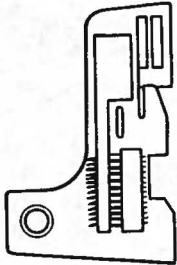

Needle clamp complete	Needle guard (overlock stitch)	Needle guard (chain stitch)	Over looper	Needle thread take - up	Upper knife
 <p>142127-0-01</p>	 <p>140108-0-02</p>	 <p>140912-0-01</p>	 <p>143733-0-01</p>	 <p>142602-0-01</p>	 <p>142198-0-01</p>
 <p>142127-0-01</p>	 <p>140108-0-02</p>	 <p>140912-0-01</p>	 <p>143151-0-01</p>	 <p>142201-0-01</p>	 <p>142198-0-01</p>
 <p>140736-0-01</p>	 <p>140108-0-02</p>	 <p>140912-0-01</p>	 <p>143733-0-01</p>	 <p>142602-0-01</p>	 <p>140242-0-01</p>

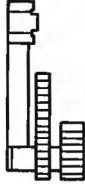
MA4-B972

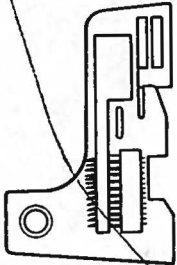
Sub class	Needle plate	Main feed dog	Differential feed dog	Chain feed dog	Presser foot complete
<p>MA4-B972-3 A</p> <p>Needle gauge 3mm</p> <p>Overlock width 5mm</p> <p>5 thread safety stitch</p>	 <p>143296-0-01</p>	 <p>143297-0-01</p>	 <p>140194-0-01</p>		 <p>140268-0-01</p>
<p>MA4-B972-3 A</p> <p>Needle gauge 3mm</p> <p>Overlock width 5mm</p> <p>5 thread safety stitch</p>	 <p>142237-0-01</p>	 <p>142238-0-01</p>	 <p>142239-0-01</p>		 <p>142240-0-01</p>
<p>MA4-B972-3 B</p> <p>Needle gauge 3mm</p> <p>Overlock width 5mm</p> <p>4 thread safety stitch</p>	 <p>142237-0-01</p>	 <p>142238-0-01</p>	 <p>142239-0-01</p>		 <p>142240-0-01</p>

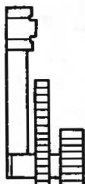
Needle clamp complete	Needle guard (overlock stitch)	Needle guard (chain stitch)	Over looper	Needle thread take-up	Upper knife
 <p>140736-0-01</p>	 <p>140108-0-03</p>	 <p>140912-0-01</p>	 <p>143733-0-01</p>	 <p>142602-0-01</p>	 <p>140242-0-01</p>
 <p>140736-0-01</p>	 <p>140108-0-02</p>	 <p>140912-0-01</p>	 <p>143733-0-01</p>	 <p>142602-0-01</p>	 <p>142198-0-01</p>
 <p>140736-0-01</p>	 <p>140108-0-02</p>	 <p>140912-0-01</p>	 <p>143151-0-01</p>	 <p>142201-0-01</p>	 <p>142198-0-01</p>

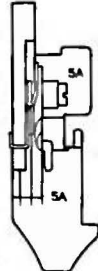
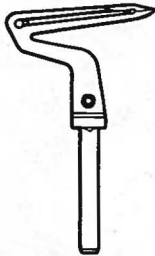
MA4-B972

Sub class	Needle plate	Main feed dog	Differential feed dog	Chain feed dog	Presser foot complete
<p>MA4-B972-5A</p> <p>Needle gauge 5mm</p> <p>Overlock width 5mm</p> <p>5 thread safety stitch</p>	 <p>140985-0-01</p>	 <p>142129-0-01</p>		 <p>140195-0-01</p>	 <p>140989-0-01</p>
<p>MA4-B972-5B</p> <p>Needle gauge 5mm</p> <p>Overlock width 5mm</p> <p>4 thread safety</p>	 <p>140985-0-01</p>	 <p>142129-0-01</p>		 <p>140195-0-01</p>	 <p>140989-0-01</p>
<p>Gauges commonly used on all sub-classes</p>	<p>Under looper</p>  <p>143734-0-01</p>	<p>Chain stitch looper</p>  <p>140161-0-01</p>	<p>Lower knife</p>  <p>118527-0-01</p>		